

G-500 Multi-Projector Processor Quick User Manual

Thank you for choosing GeoBox. GeoBox is an advanced dual channel video processor with patented warp technology. It is a standalone system capable of image stacking, video wall, edge blending and active/passive 3D demultiplexer with precise geometry adjustment. No additional video distributor, tool or computer is required for the setup.

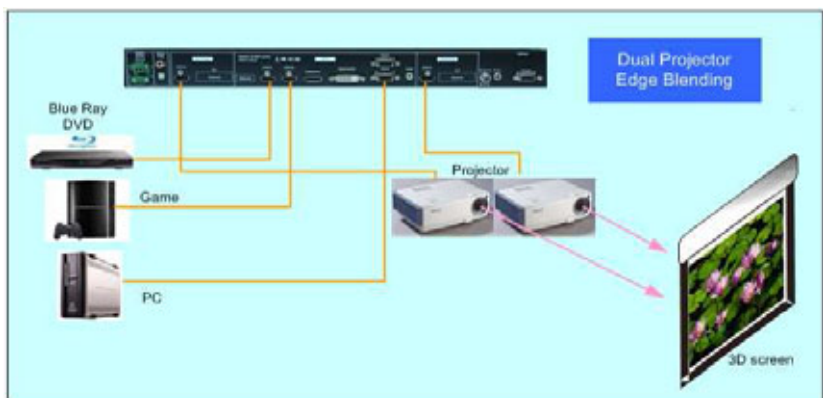

Features and block diagram

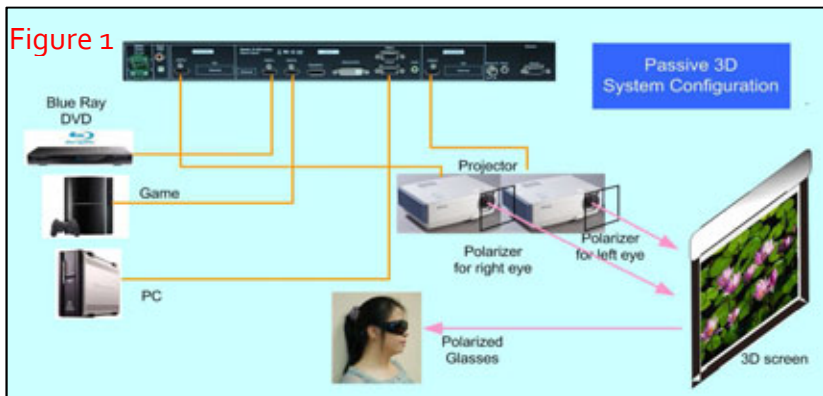

1. Support WQXGA/3840*1080 input
2. Precise geometry adjustment for easy system installation and stacking
3. Support HDMI 1.4 standard 3D formats from Blue Ray, game, PC...
4. Multiple input ports to allow flexible input source selection
5. 10 bits scaler with high performance de-interlace and scaling
6. Multi-projector video wall and edge blending functions in G-502 model
7. Edge blend and image stacking for active and passive 3D display
8. Special algorithm for perfect RH/LH synchronization in 3D mode
9. User friendly OSD and IR remote control. No PC is required
10. IR extender, Ethernet & RS232 control
11. 3x trigger outputs for system control
12. Support curved screen 3D display
13. Support PC Nvidia 1080p/120Hz for passive 3D display

Limited Warranty

This device is designed and tested to the highest standards and backed by a two years parts and labor warranty. Warranties are effective upon the first delivery date to the end customer and are non-transferable. Warranty related repairs include parts and labor, but do not include repair of faults resulting from user negligence, special modifications, abuse (mechanical damage), shipping damage, and/or other unusual damages. The customer shall pay shipping charges when the unit is returned for repair. Manufacturer will pay shipping charges for return shipments to customers.

Manufacturer does not assume responsibility for consequential damages, expenses or loss of revenue, inconvenience or interruption in operation experienced by the customer. Warranty service shall not automatically extend the warranty period.

FCC/CE statement

This equipment has been tested and found to comply with the limits for a Class A digital device, pursuant to part 15 of the FCC Rules. These limits are designed to provide reasonable protection against harmful interference when the equipment is operated in a residential / commercial environment. This equipment generates, uses, and can radiate radio frequency energy and, if not installed and used in accordance with the instruction manual, may cause harmful interference to radio communications. Operation of this equipment in a residential area is likely to cause harmful interference in which case the user will be required to correct the interference at his own expense.

Outlook and Functions

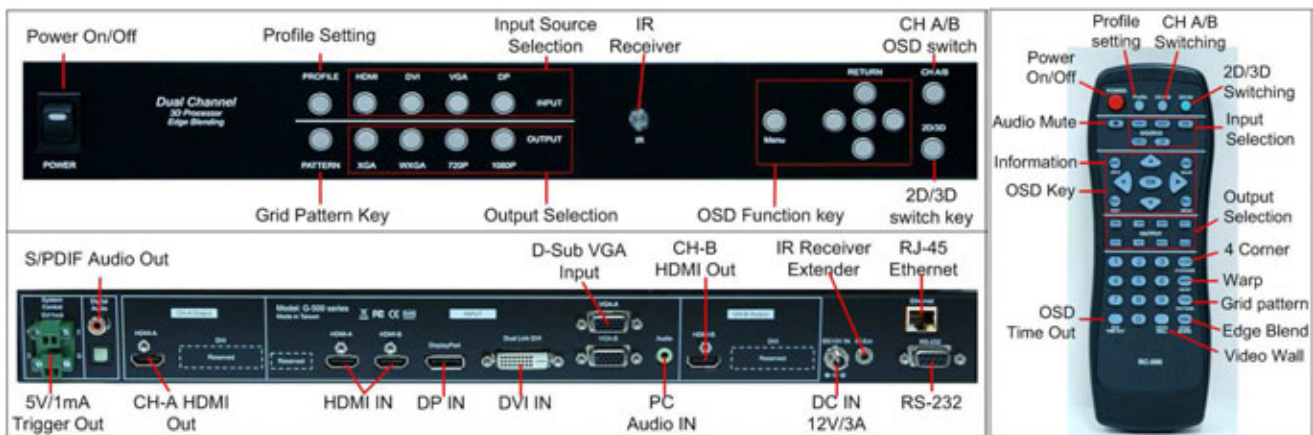

Help tips

1. Toggle on HDMI (VGA) input key will circulate between HDMI-A & HDMI-B (VGA-A & VGA-B) inputs.
2. Toggle on CH A/B keypad will circulate the OSD control between CH-A & CH-B.
3. Toggle on 2D/3D keypad will circulate between Side By Side 3D mode and 2D (or auto 3D) mode.
4. In order to avoid interference among multiple GeoBox during the installation, user can set ID number for each GeoBox through [Options] in OSD Menu. Press number keys in Remote Controller for the control of multiple GeoBox:
 - 850: simultaneous control for all GeoBox
 - 851: control GeoBox ID No. 1
 - 853: control GeoBox ID No. 3
5. OSD Lock / Unlock: When continuously press [MENU] key in Front Panel or IR Remote Controller for 12 seconds, the OSD function will be locked to prevent from the changes of the settings by other people. To press MENU key for 12 seconds again, it will unlock OSD and user can manipulate the OSD again.
6. Picture menu in the OSD can only be activated while the input signal is not in color [Preset Mode]. To select [Image Properties] → [Custom] → [Save], then user can activate [Picture] menu again.
7. [Image Setup] menu will not be activated if the input source is not from VGA.
8. Procedures to do system Reset: OSD Menu [Options]→[Reset]→[Reset All]
9. Please select digital signals output to projector (HDMI or DVI) to avoid image position shift. If VGA output should be selected, please set projector without implementing Auto-Adjustment in VGA input.
10. Each Internal Test Pattern Grid represents 50x50 pixels no matter which input resolution is selected.
11. Continuously press PATTERN button, internal test pattern will show different colors for easy installation:
White—Red—Green—Blue—Blank

Minimum Equipment required for 3D display

1. 1x GeoBox	4. 1x 3D screen (silver matte)
2. 2x Projectors (Native resolution above XGA with HDMI input connector)	5. 3D glasses (Paired with polarizer)
3. 2x polarizers (For RH & LH eyes)	6. 3x HDMI cables
	7. Video source with 3D content

Installation process for 3D display

1. Install projectors & screen to let projection images a little over the screen without going through GeoBox. Make sure to avoid heat ventilation interference in the setup.
2. Connect all the cables and GeoBox RH output connects to RH projector and LH output to LH projector.
3. Reset GeoBox to factory default settings via OSD [Option] menu to ensure no unexpected settings.
4. Set polarizer into RH & LH projectors before geometry alignment. Make sure the RH/LH polarizers are set in correct projector, direction and angle with distance of 5-15cm to the lens to avoid thermal damage.
5. Blue Ray player should be set at AUTO 3D (or 1080p@24Hz) for 1080p frame packing 3D display.
6. Turn on all devices. Some projector will search input source several times due to input timing change and HDCP validation. GeoBox will automatically connect to input source. Then the screen will show up with double images. To set HDMI as projector input may reduce the time for input searching. If no input source is detected, GeoBox will go into power saving mode. The screen will show [Power Saving Mode] message.
7. Select correct input source and set output resolution to match projector native resolution.
8. Make sure two projectors are in good focus and have the same settings.
9. Use [OSD Time] hot key in remote controller to set OSD Time Out to [Off] to show OSD & grid pattern all the time during image alignment and 3D settings period.
10. Align two projector images together via [4 Corner] adjustment.
11. [3D Properties] setting to get correct input format and 3D settings.
12. Test the final result and 3D performance.

13. Two projector Image alignment procedures using remote controller

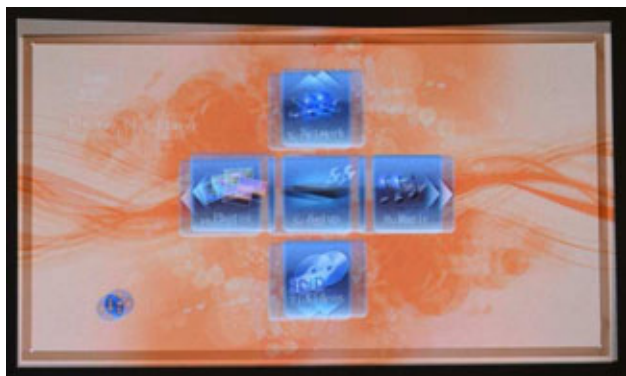

1. Power on the system after installation, double images will appear on the screen.
2. Set [OSD Time Out] to [Off] to show OSD & grid pattern all the time during system setting period.

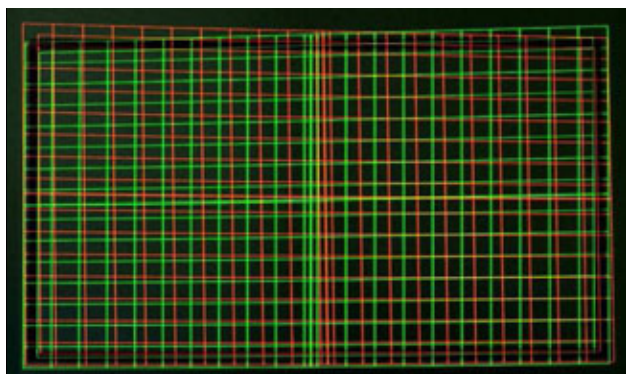

1. Press [Pattern] key to show Grid pattern in CH-A. Continually press [Pattern] key will change the grid color.
2. Press [CH A/B] key to switch to the 2nd channel, then press [Pattern] key again to show grid pattern in the 2nd channel.
3. Left figure shows CH-A in Red and CH-B in Green color.

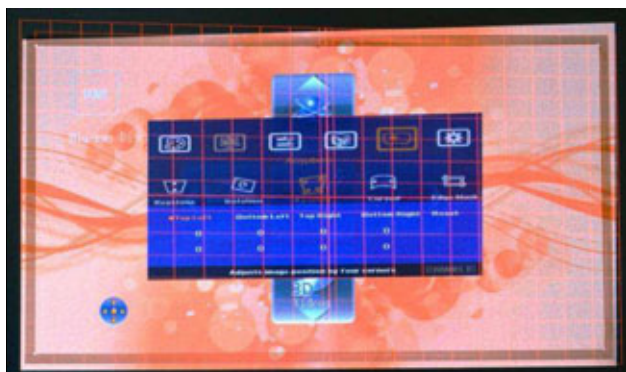

1. Press [4 Corner] key will show [4 Corner] OSD menu in one channel and another channel still retain grid pattern.
2. User will see [Channel B] indicator at the bottom right of the OSD to show the channel to be adjusted.
3. Select the corner to be adjusted by OSD direction keys--[Top Left] is selected in the example.

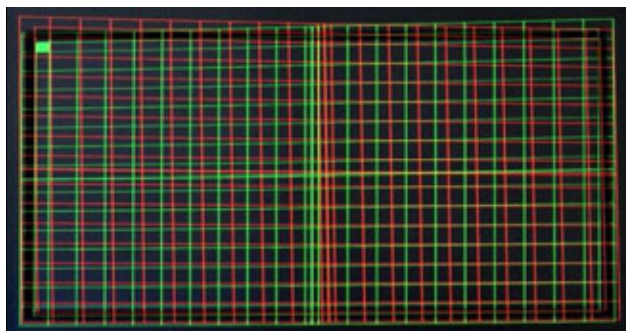

1. After press [OK] key, a Green Mark will be showed at the corner to be adjusted.
2. Left figure shows CH-B [Top Left] corner is selected and under adjusting.
3. Use OSD direction keys to adjust the position of the corner into screen border.



1. When finish the adjustment in Top Left corner in CH-B, don't press [OK] key.
2. Press [CH A/B] key to switch to CH-A.
3. [4 Corner] OSD menu for CH-A will be showed with [Channel A] indicator at the bottom right of the OSD.
4. Select [Top Left] corner and press [OK] key, a RED Mark will be showed at [Top Left] corner to indicate the corner to be adjusted.

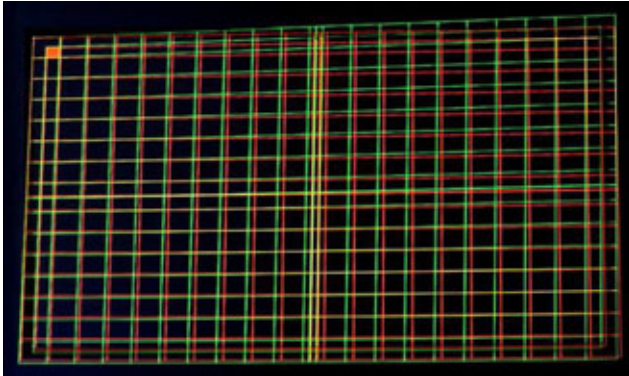

Use OSD direction keys to adjust CH-A [Top Left] corner to match CH-B [Top Left] corner, then press [OK] to go to next step.

(If grid pattern disappears, press [Pattern] & [CH A/B] keys to activate grid patterns in both channels)

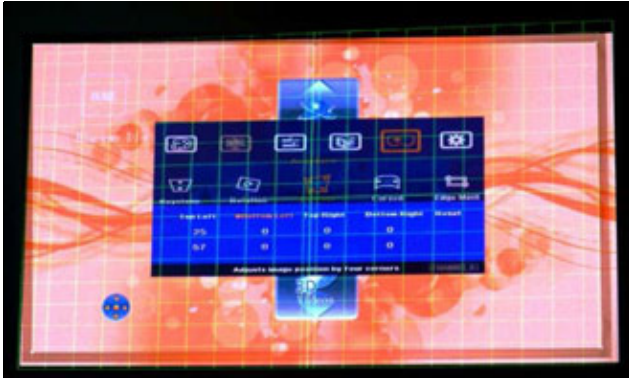

1. After press [OK] key, it will show [4 Corner] menu again in CH-A.
2. Select the second corner to be adjusted.
3. Press [OK] key, then it will show Red Mark at the selected corner.
4. To adjust the position of the corner to match the screen border by direction keys.
5. Press [CH A/B] to switch to CH-B and do the same corner adjustment process.

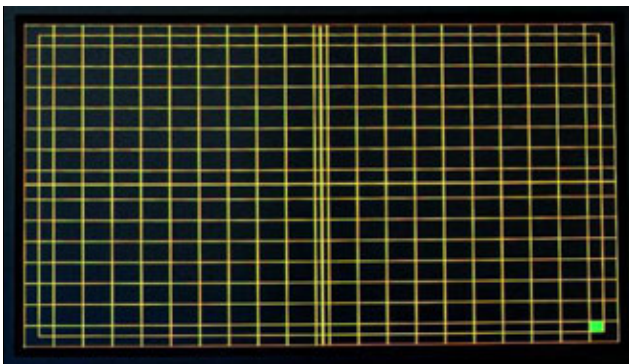

After all corner positions have been aligned together with the screen. The grid patterns from CH-A & CH-B will overlap together and show only one grid pattern.

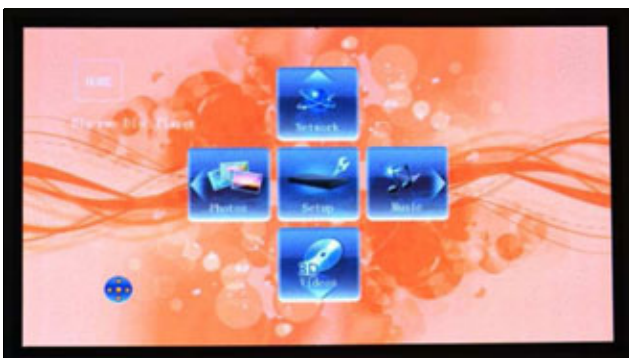

1. Press [Exit] in remote control to turn off grid pattern in one channel.
2. Switch to 2nd channel by [CH A/B] key, then press [Exit] again to exist from the 2nd channel.
3. User will get clear image after this process, if not, please fine-tune the alignment. Then user can start [3D Properties] setting.

The above [4 Corner] alignment process can be applied to both 3D alignment and Image Stacking in flat screen display. If curved screen 3D display is required, user needs to use [Warp] function in OSD menu to align the images from two projectors together. [Curved] function includes [Shift] (4 Corner adjustment), [Corner] curve, [Edge] curve and [Center] curve adjustments.

Procedures for 3D display setting in GeoBox

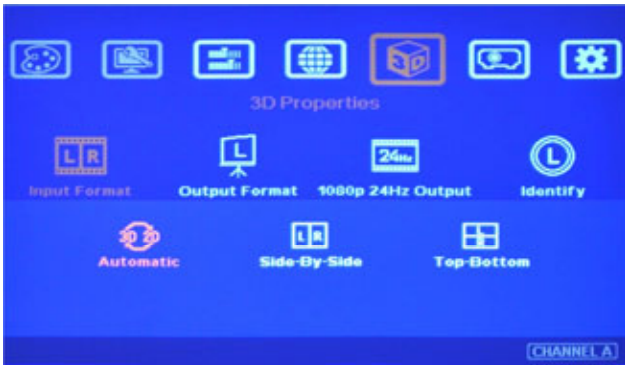

1. After [4 Corner] adjustment, to activate [3D Properties] in OSD to select 3D formats.
2. Select [Automatic] if the 3D signal is standard 3D formats from Blue Ray player.
3. Select [Side By Side] or [Top-Bottom] based on user's 3D input sources.

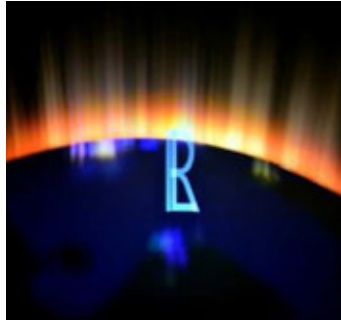
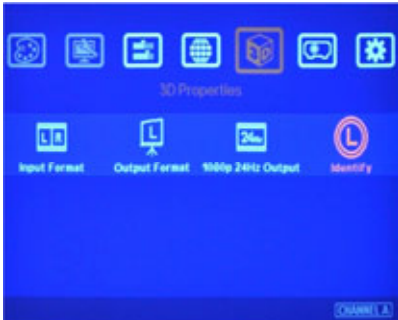

1. Activate [Identify] menu to show "R & L" characters on the screen simultaneously to verify the final 3D settings in the system.
2. RH eye should see only "R" and LH eye should see only "L".

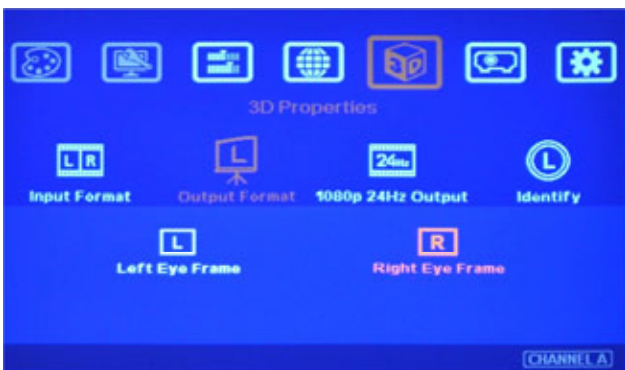

1. If it is not the result, then to set [Output Format] in OSD menu is required.
2. Please swap [Left Eye Frame] and [Right Eye Frame] in both RH/LH output channels to see the right "R" & "L" characters in both eyes.
3. Complete system check is required if the problem still existing.

If still can't verify "R" & "L" characters in both eyes, please check below again:

1. Is the screen for 3D display?
2. Are the Glasses and polarizers the same types and paired for the RH & LH eyes?
3. The default output setting of CH-A is for RH eye and CH-B is for LH eye. Please check from [Output Format] menu as above figure and make sure [Right Eye Frame] is set in CH-A and [Left Eye Frame] is set in CH-B.
4. Is the Blue Ray player set to [Auto 3D] or [1080p frame packing] mode to deliver 3D signal out?
5. If Side by Side or Top-Bottom 3D formats are used, please check the aspect ratio in video source output to make sure GeoBox will receive full screen image.
6. Is there any HDMI or signal source compatibility issue and only one projector shows image?

After above procedures, apply 3D signal source and wear 3D glasses, then user can enjoy the most comfortable and healthy 3D system. It is the best solution for children with minimum harm to eyes.

Projector installation and setting guide for 3D display

1. Two projectors can be installed side by side or top-bottom. Closer position will reduce 4 corner adjustment ranges and reduce the loss of the image resolution and brightness. Please make sure ventilation hot air will not affect each other.
2. Maximum [4 Corner] adjustment range in each corner is ± 256 pixels horizontally (max. 300 pixels in Left + Right) and ± 200 pixels vertically (Top + Bottom). For output resolution above 1400 x 1050, the range will be H: ± 150 & V: ± 100 . Please make sure the installation of the projectors can meet this limits. Each grid pattern is 50x50 pixels before implement 3D function and will be 50x100 pixels after implement 3D.
3. GeoBox can support passive 3D display on curved screen through [Anyplace]→ [Curved] function in OSD.
4. The output brightness of the projector will differ in different Display Modes. User needs to select one with higher brightness and enriched color. "Presentation" mode will give higher brightness but the color will differ from original. sRGB will give user better color but the output brightness is usually comparative low. Two projectors should have the same color settings to get the best 3D performance.
5. During the installation, the distance between the polarizer and the projector should be over 5cm to avoid thermal damage due to high temperature from the projector. Higher lumens projector will create more heat and the distance should be larger. The polarizer can only tolerate up to about 60~70°C.
6. If 2D & 3D display is required in the same setup, user can keep the polarizer in the system but the total brightness of the system will be lower. If user wants to enhance the brightness, there should be a mechanism to remove the polarizers while the system switching to 2D display. For 2D display, it is necessary to do different geometry alignment because the polarizers will change the light path. If necessary, user can do alignment based on 2D display without polarizer and put on polarizers for 3D with the same alignment settings because 3D display allow small geometry shift. Different settings in geometry adjustment can be stored in GeoBox [Profile] menu and recall through OSD.
7. GeoBox HDMI connector may be damaged by an unqualified HDMI cable. Please use qualified HDMI cable and carefully plug in and out.
8. Pay attention to the HDMI compatibility due to different cables, equipment and connection distance. If the distance is too long, HDMI extender shall be considered. It may extend the distance up to 50m to 100m.

Screen selection guide for 3D display

1. Silver Matte screen is required for polarized 3D display. Spectrum filter 3D system can use conventional screen. Some factors are important in polarized 3D display screen:
 - i. The ability to retain polarization: higher value will have less ghost cross talk.
 - ii. Gain value: high value will have better brightness but may have viewing angle and hot spot issues.
 - iii. Flatness of the screen: Viewer may see wave screen and dis-alignment in geometry, especially in short throw ratio projectors. It may be OK for 3D display but it will yield blurred image in 2D display.
2. The prices in different 3D screens have big range. Paint for 3D screen is available in the market.
3. If 2D & 3D display is required. User can select a screen with 2D/3D ability in the market.
4. Cheap silver paint and clothes with silver paste coating can be used as a temporary means to verify the function of the 3D system if no 3D screen is available.

Projector selection guide for 3D display

1. It is not necessary to use expensive projectors with lens shift or special geometry alignment rack because GeoBox can do pixel by pixel precise geometry adjustment.
2. A normal projector can be chosen for 3D display (no need to have 3D ready). Usually, XGA resolution will create acceptable 3D video quality. A projector with higher native resolution, output brightness and contrast ratio, will yield better performance similar to Movie Theater.
3. The output light from a projector with 3x LCD micro display (such as Epson) or LCOS (JVC or Sony) may preserve polarization and the polarizer and glasses need to be carefully selected. Linear polarized system can be used in Epson 3x LCD projector but circular polarized system can't. Optical spectrum type filter and glasses can be an alternative in this case. DLP type projector is easier in polarizer and glasses selection.
4. The projector with throw ratio under 0.8 is not recommended because it will be more sensitive to the flatness of the screen and create difficulty in the installation.
5. DLP projector for PC graphics display purpose may use different color wheel for higher brightness but degrade the color performance. Please select video projector with HDMI input for home theater application.
6. For use in public area, the projectors with higher brightness should be considered. Projector with more than 3,000 lumens will be acceptable in limited ambient light controlled area. More than 4,000 lumens will create better 3D effect. Projector with full HD resolution and 2,000 lumens will be recommended for home theater.

Other Important Tips for 3D display

1. The final brightness to the eyes will be reduced due to 3D polarizer and glasses. Passive 3D brightness to the eyes will be about 3x if compared with the same projector used in active (shutter) 3D system.
2. Incorrect aspect ratio adjustment of signal source may cause abnormal 3D display when the 3D format is Side by Side or Top-Bottom.
3. Pair the glasses and polarizer is required: If viewer wears 3D glasses and sees the light from lamp through one polarizer via RH eye with different side, direction and angle, viewer will see below conditions:
 - i. If RH eye can see through the polarizer at any side, direction and angle, then this polarizer is not for RH eye. It should belong to LH eye projector.
 - ii. If viewer can't see through or only see minor light at some angle or direction, then it can be for RH eye projector. The side faced to the eye should be pointed out to the screen and the polarizer should be installed at the same angle as viewer sees minimum light through.
4. GeoBox doesn't have VGA output. Using HDMI to VGA conversion box to connect projector through VGA port is not recommended because projector may change the geometry alignment due to "Auto Setting" during system boot up stage, unless "Auto Setting" function in projector can be turned off.
5. It is possible for the system to hung up during image adjustment. In this case, system will restart within one minute. User can also turn OFF/ON the system to restart again. This kind of situation will not happen once the complete system setup is finished. It will not affect the stability of the whole system.
6. If 3D setting in Blue Ray is not correct, GeoBox will not be detected and 3D signal can't be delivered to GeoBox. Please set Blue Ray at auto 3D or 1080p@24Hz frame packing.
7. Usually front projection 3D screens will be silver (aluminum) surfaced in polarized 3D system unless optical

- spectrum filter system from Dolby or Infitec has been used. Optical spectrum filter system can use normal 2D screen and minimized the ghost effect (crosstalk) but the filter and glasses will be in higher prices.
8. There are many kinds of 3D polarization system with different polarizing angles or directions. User needs to check whether the glasses can match exactly with polarizer being used for the projectors.
 9. Please note that head tilting and different viewing angles will affect crosstalk in linear polarization system.
 10. It is necessary to recheck the overlap condition of the projectors if there is any output mode change. If necessary, please use [Profile] to store different settings.
 11. In Side by Side or Top-Bottom 3D input mode, user may not see full OSD display from the video sources on the screen. To set correct video source before implement 3D mode.
 12. Although GeoBox is the most advanced and comfortable 3D control system, 3D screen, polarizer and glasses are also important factors for a perfect 3D system.

Flat screen Edge Blending installation guide (only available in G-502 model)

1. Please use [Excel Spread Sheet] provided by dealer to calculate the number of projectors and overlap pixels between projectors. Make sure enough brightness on the screen with aspect ratio matching the content.
2. Placement of Projectors:
 - Select projectors with higher contrast ration (above 3000:1 is recommended) and set projectors at reasonable distance from the screen with 200-500 overlap pixels between two projectors.
 - Use removable tape as temporary marks to show the display ranges for each projector. Each projector should have the same display size. Otherwise the grid size in each projector will be different and the blending image will become blurred.
 - To project each projector a little over the display range for further geometry adjustment.
 - To set parallel vertical or horizontal overlap edges between 2 adjacent projectors will get better video quality in Edge Blending image.
3. Projector setting:
 - Reset projector to default setting
 - Disable Auto Keystone function and set new keystone value to let vertical edges in adjunction images in parallel vertically.
 - Select sRGB Display Mode will reduce the color difference in overlap area.
 - Use projector internal color adjusting function to adjustment the color variation among projectors.
4. GeoBox Setting
 - Reset GeoBox to default setting.
 - Select the input source and best output resolution to match projector native display resolution.
 - Set [OSD Time Out] to [OFF] to maintain the display of OSD and Internal Test Pattern during the installation period.
 - To set Color in [sRGB] or [Neutral]. Preset Mode will create better Edge Blending result. (OSD menu [Image Properties]→[Color]→[Preset Mod]e→[sRGB/Neutral])
5. Four Corner geometry Adjustment

To adjust the corner positions in each projector to match preset marks in the screen. After all projectors are projecting at the right preset positions, then to do accurate position fine-tune is required to let all the grids in overlap area able to align perfectly. If the system is for 3 projector edge blending, the center projector should

be aligned first then to align the rest two projectors to match center projector. To use projector internal keystone to get vertical edges in center projector will be easier to get better edge blending result.

If the screen is curved or not flat and the grids in overlap area can't be perfectly aligned, then additional GeoBox is required for curve (warp) alignment. Please contact dealer for more details.

6. Video Wall setting (Image split and allocation)

After [4 Corner] adjustment, video wall setting is required. The functions of video wall are as follows:

- Split the image for different projectors
- Determine the location of the image for each projector
- To set proper overlap region in the edge between projectors

Example for 3x2 matrix edge blending:

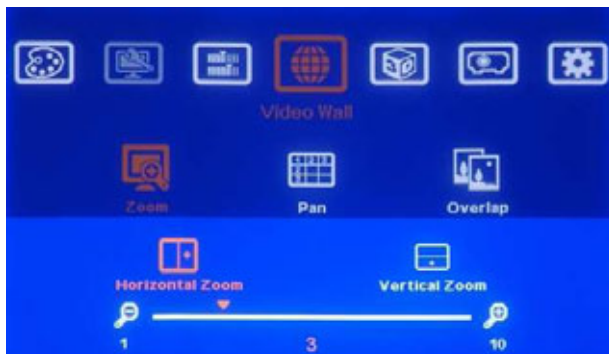

- Select [Horizontal Zoom] → [3] to split the image for 3 projectors horizontal edge blending configuration.
- Select [Vertical Zoom] → [2] to split the image for 2 projectors vertical edge blending configuration.

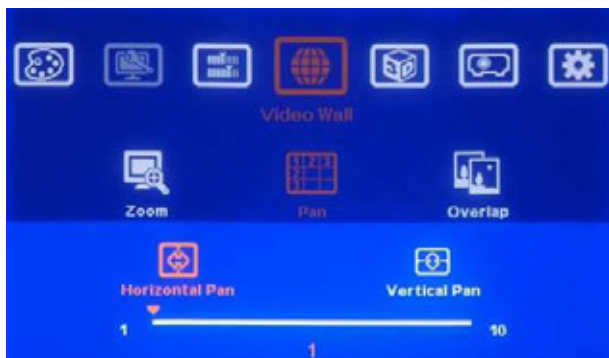

- Select [Horizontal Pan] → [1] and [Vertical Pan] → [2] to assign the projector to [Bottom Left] position
- Select [Horizontal Pan] → [3] and [Vertical Pan] → [1] to assign the projector to [Top Right] position

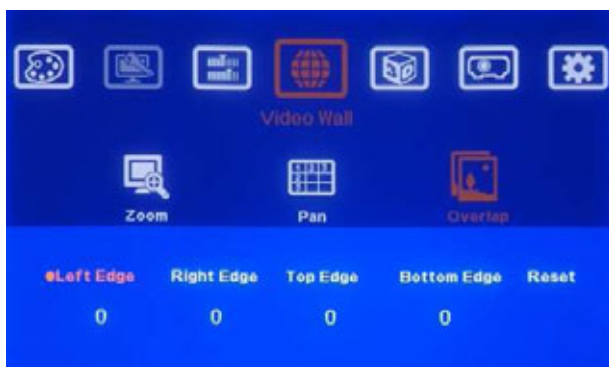

Use Overlap function to align the zoom ratio and image position between adjacent projectors. Correct adjustment will eliminate double image in the screen

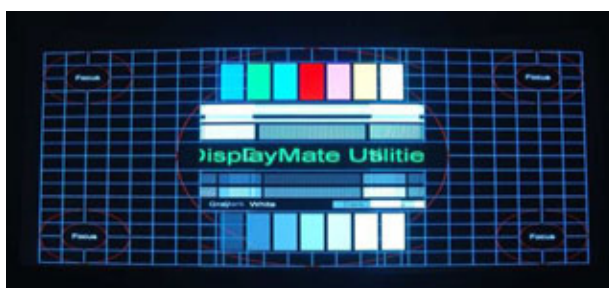

Left figure:
Before Overlap adjustment: Double image in the center overlap region.

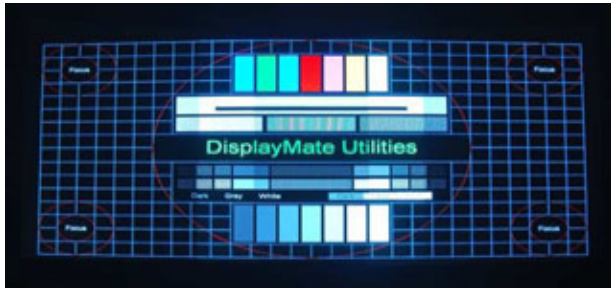

Left figure:
After Overlap adjustment: No double image in the center overlap region.

An [Excel Spread Sheet] can be provided for the calculation in different setup. Below is the calculate result of Video Wall [Overlap Value] for 2 projector edge blending. If no [Excel Spread Sheet] can be used, user can see the image changes of projectors during OSD Overlap value adjustment and determine the value.

Video Wall [Overlap] value in dual projector horizontal edge blending									
Input to GeoBox	Output to projector	Overlap 5 grids		Overlap 6 grids		Overlap 7 grids		Overlap 8 grids	
		Overlap	Aspect	Overlap	Aspect	Overlap	Aspect	Overlap	Aspect
XGA	XGA	51	2.34	88	2.28	106	2.21	124	2.15
720p	XGA	89	2.34	110	2.28	132	2.21	155	2.15
1080P	XGA	133	2.34	165	2.28	198	2.21	233	2.15
XGA	720P	55	3.21	68	3.14	81	3.07	95	3.0
720p	720P	69	3.21	85	3.14	101	3.07	119	3.0
1080P	720P	104	3.21	127	3.14	152	3.07	178	3.0
XGA	1080p	36	3.32	43	3.28	51	3.23	60	3.19
720p	1080p	45	3.32	54	3.28	64	3.23	74	3.19
1080P	1080p	67	3.32	81	3.28	96	3.23	112	3.19

Remarks:

- "Overlap" means the pixel # in Video Wall Overlap in the overlap region in each projector. LH projector needs to apply the value to RH Edge and RH projector needs to apply to Left Edge.
- "Aspect" means the output image [Aspect Ratio] between horizontal size and vertical size.
- The Edge Blending Value is the # of overlap grids x 50 (i.e. 6 grids means overlap 300 pixels)
- Overlap region less than 250 pixels can be implemented but the edge blending quality will be more difficult to control.

- Video Wall [Overlap] setting is to decide the cropping area for each projector so that two projector overlap regions can match together with the right position and scaling ratio. It is not a real overlap pixel # between adjacent projectors. User will see double brightness in overlap region before further [Edge Blending] setting.
- Edge Blending setting is to let two images in overlap region merged gradually in different directions to become one seamless image. The setting value is based on the actual overlap pixel number. For instance, if the overlap is 6 grids, then the setting value is 6x50=300 pixels because each grid is 50x50 pixels in internal test pattern. Below are the procedures for Edge Blending value setting.



- Activate [Edge Blend] menu under [Anyplace]
- 5 function under [Edge Blend] menu for edge blending and quality fine tune.

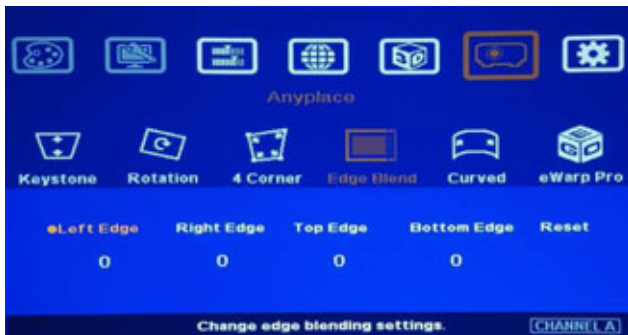

- Select correct Edge of the overlap region:
- Select Right Edge for LH projector in dual projector edge blending and select Left Edge for RH projector.

- Set Edge Blending values in the overlap edge based on the overlap pixels (each overlap grid represents 50 pixels—5 grids mean overlap 250 input pixels).
- Fine tune color
 - ◆ Select different [Gamma] and LUT values and check video performance.
 - ◆ Set right [Offset] value to compensate black level difference.
 - ◆ Eliminate the banding line via [Shift] blending position.

9. Image quality fine tuning

- The final performance will be a combination of many factors—projector characteristics, projector setting, screen, ambient light, GeoBox setting. Banding in overlap area under dark environment is caused by low contrast ratio projectors due to light leakage in the projector optic system.
- The factors affect final image quality
 - i. GeoBox settings:
 - a. Edge Blending: Gamma, Shift, Offset, Gain
 - b. Image Properties: To select Preset Mode to sRGB, Neutral or Bluish
 - ii. Projector:
 - a. To adjust installation position of the projector and deduce keystone angle.
 - b. Increase Overlap region & Reduce off axis angle
 - c. To change Display Mode, usually sRGB will get the best result.
 - d. Try different color settings. If necessary to use 3D color adjustment in the projector.
 - e. To implement 3D color adjustment.
 - iii. Screen: To use lower gain value screen.

Projector image stacking procedures

1. Image stacking is a cost effective solution to increase the brightness of the projection system. User can use three low cost projector with 3,500 lumen to stack up to 10,000 lumens easily at much lower cost.
2. One G-501 can do 3 projector stacking. If 3 projector stacking is executed, it is necessary to add one video distributor at the front of G-501. The first projector should be connected directly to HDMI splitter with native raw signal without processing by GeoBox and the other two projectors should be connected to RH & LH output ports of GeoBox.
3. To apply grid pattern from external signal source during geometry alignment process.
4. To do geometry adjustment in the first projector to let the image match the screen borders through keystone correction or lens shift function inside the projector.
5. To use [4 Corner] adjustment to align the images from the 2nd and 3rd projectors on to the first one.
6. For curved screen stacking, only two projector can be used through [Warp] function in GeoBox unless the first projector can support curved screen display as well.
7. If the screen is not flat enough, the image sharpness will be reduced.

Technical support

Please check more technical information in www.vnstw.com website:

Technical support: Steve Wang, HH Lin

Tel: +886-2-8751-2785 ext. 301/305

E-mail: support@edi-tw.com Website: www.edi-tw.com